

## YDS-G1M9WF3+YDS-CMFL1117C-IMX283 V1.0

**Ai Master Board + WiFi Board + 20.3MP Sony IMX283 Fixed Focus Camera Module Development Kit**

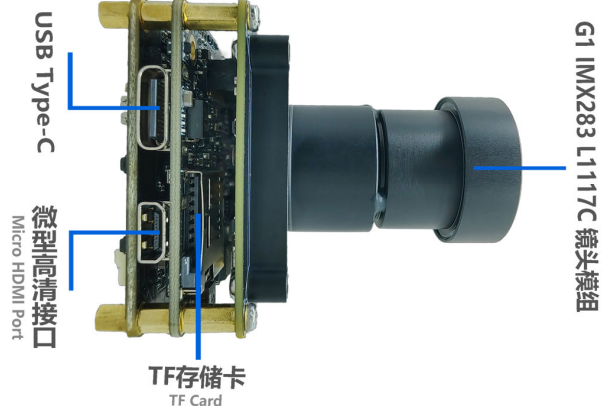

G1 IMX283 L1117C 镜头模组

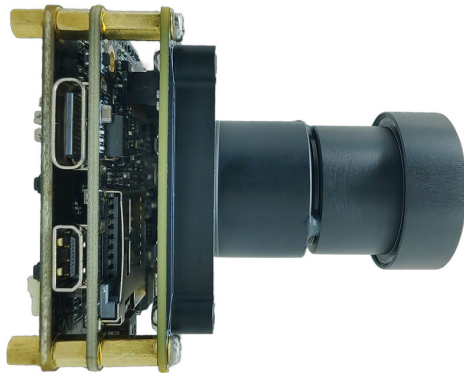
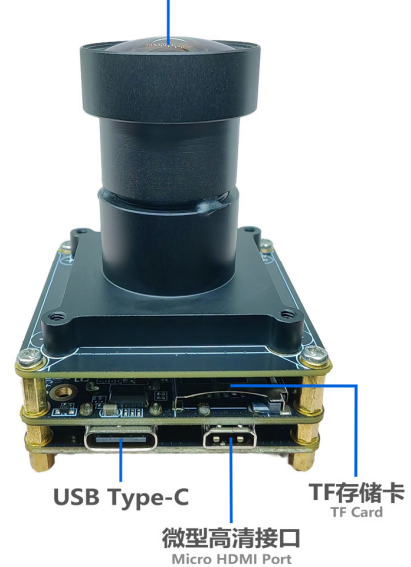

## YDS-G1M9WF3+YDS-CMFL1117C-IMX283 V1.0

**Ai Master Board + WiFi Board + 20.3MP Sony IMX283 Fixed Focus Camera Module Development Kit**

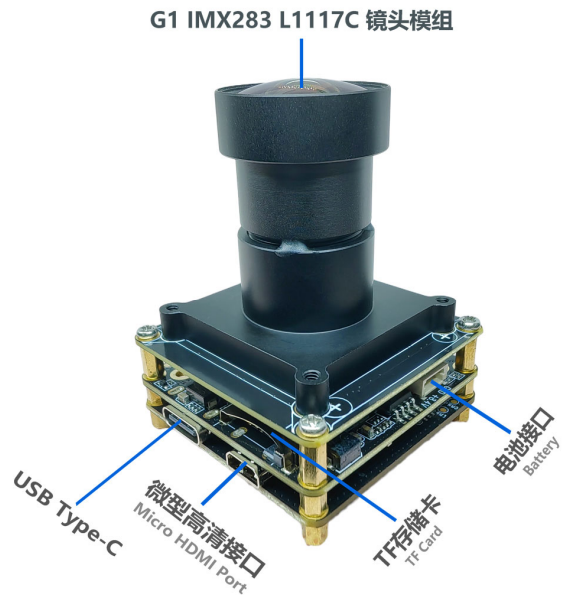
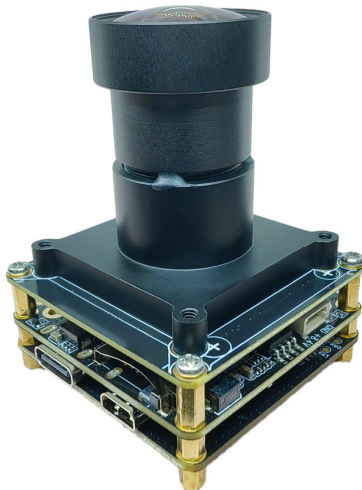
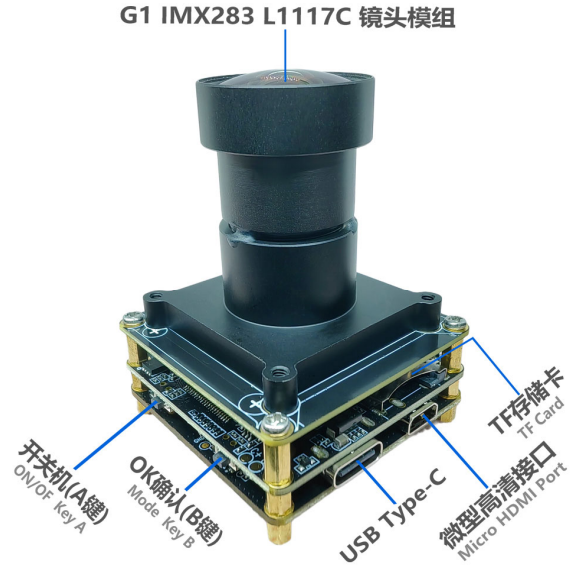
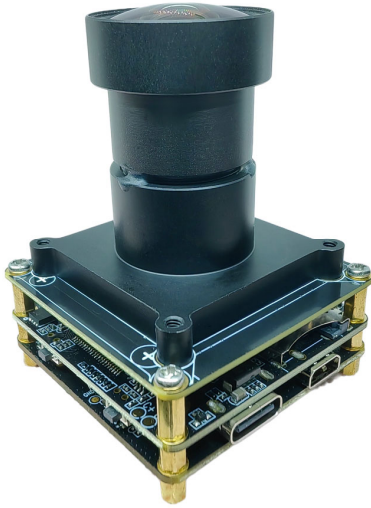

## YDS-G1M9WF3+YDS-CMFL1117C-IMX283 V1.0

**Ai Master Board + WiFi Board + 20.3MP Sony IMX283 Fixed Focus Camera Module Development Kit**

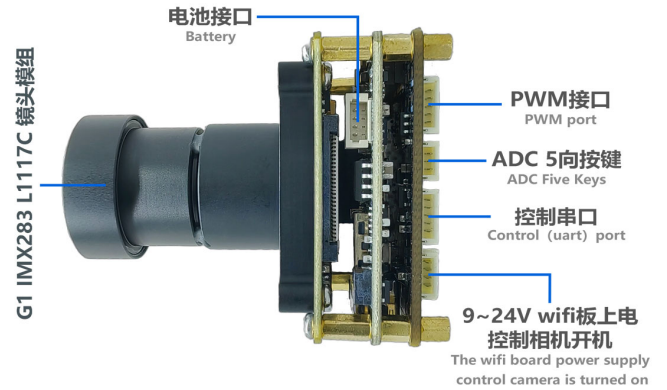
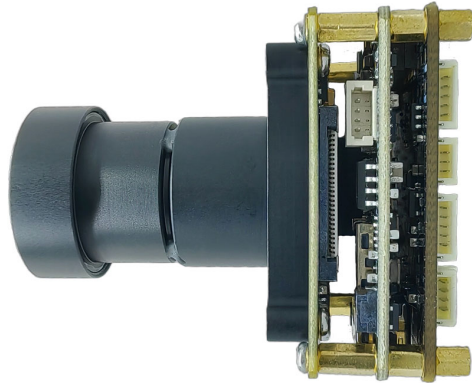

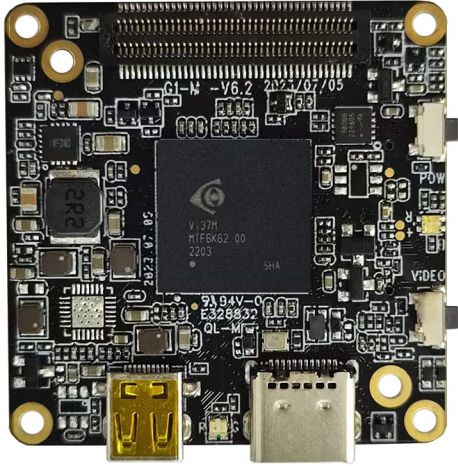
**YDS-G1M9 V6.2****iCatch V39 Ai-Powered Image Processing SoC Master Board**

Front View

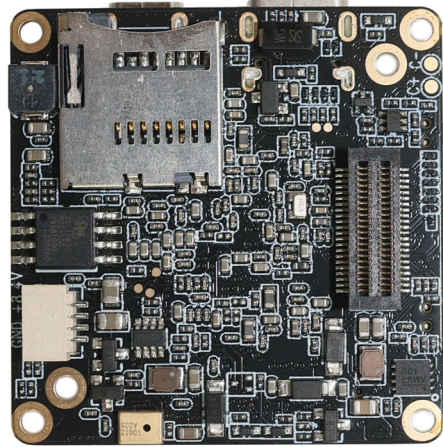

Back View

**Overview**

Equipped with iCatch V39, built-in 2GB DDR3, supports up to 4K@60FPS (differential), 4K@30FPS, 1080P@120FPS H.264 encoded video. Onboard support Type-C, HDMI, TF memory card, recording, 2 control buttons, buzzer, battery power supply, etc.

This master board extension also supports WiFi, LCD display, CVBS, lens module, UART, I2C, SPI, PWM, MIC and other expansion interfaces. The board size is 38x38mm. Widely used in drones, mini DV, wearable devices, sports cameras, face recognition, USB cameras and other camera products.



## YDS-G1M9 V6.2

### iCatch V39 Ai-Powered Image Processing SoC Master Board

#### Hardware Specifications

<b>Model No.</b>	<b>YDS-G1M9 V6.2</b>
<b>Main Control Chipset (DSP)</b>	iCatch V39
<b>Image Sensor Interface</b>	MIPI
<b>Battery Voltage</b>	7.4V - 7.7V High Voltage Lithium Battery
<b>Storage Type</b>	External TF Card, Supports 8GB - 512GB Class 10 and Above, U3 is Recommended
<b>Type-C Port</b>	Type-C USB 5V Connection to Computer USB Mode Connection to PCCAM (Camera) Mode
<b>LED Indicator Type</b>	Three Color Light (Red, Green, Blue)
<b>2 Control Button Type</b>	Power Button (A), OK Button (B)
<b>Power Supply</b>	Supports 3 Power Supply Methods At The Same Time (1) 5V USB to Type-C Port Power Supply (2) 9V-24V WiFi Board or Network Port board Power Supply (3) 6.8V-8.4V Battery Power Supply (The 3-Axis Gimbal Version Does Not Support 5V USB)
<b>Operating Temperature</b>	-10°C to +60°C Without Housing
<b>Storage Temperature</b>	-20°C to +80°C
<b>Humidity</b>	20% to 80%
<b>PCB Dimensions</b>	38 x 38 mm
<b>PCB Screw Hole Spacing</b>	External (34mm x4), Internal (28mm x2)
<b>PCB Screw Hole Diameter</b>	2 mm
<b>Optional Camera Configuration</b>	(1) YDS-G1M9 V6.2 + Camera (2) YDS-G1M9 V6.2 + Camera + YDS-G1WF V6.3 WiFi Board (3) YDS-G1M9 V6.2 + Camera + YDS-G1NK V6.3 Ethernet Board
<b>Supportive Image Sensors</b>	13MP: IMX258 12MP: IMX377 OS21D40 IMX577 IMX386 IMX378 8MP: IM317 5MP: IMX335 2MP: IMX290 IMX385
<b>Optional Extension Ports</b>	WiFi, Ethernet Network Port, Display, Audio IC, Lens Module, UART, I2C, SPI, PWM, MIC, etc.

## YDS-G1M9 V6.2

### iCatch V39 Ai-Powered Image Processing SoC Master Board

#### Photo Image Settings

<b>Resolution</b>	20MP, 13MP, 12MP, 10MP, 8MP, 5MP, 3MP, 2MP
<b>Time Lapse Photography</b>	OFF, 3S, 5S, 7S
<b>Continuous shooting</b>	OFF, 3-Shot, 7-Shot, 15-Shot, 30-Shot
<b>White Balance</b>	Auto, Sunny, Cloudy, Fluorescent, Incandescent
<b>Power Frequency</b>	50Hz, 60Hz
<b>Exposure Compensation</b>	EV 0.0, EV 3.0, EV 7.0, EV 10.0, EV 13.0, EV 17.0, EV 20.0, EV -3.0, EV -7.0, EV -10.0, EV -13.0, EV -17.0, EV -20.0
<b>Time Lapse Photo Interval</b>	OFF, 1S, 2S, 3S, 4S, 5S, 6S, 7S, 8S, 10S, 13S, 15S, 20S, 25S, 30S, 40S, 1min
<b>Time Lapse Duration</b>	No Limit, 1min, 3min, 5min, 10min, 20min, 30min, 1hr, 2hr, 3hr, 5hr
<b>Photo Time Watermark</b>	OFF, Date, Date and Time

#### Wifi、显示屏、网口、uart、PWM等扩展接口

For Wifi, Display, Network, uart, PWM Etc.

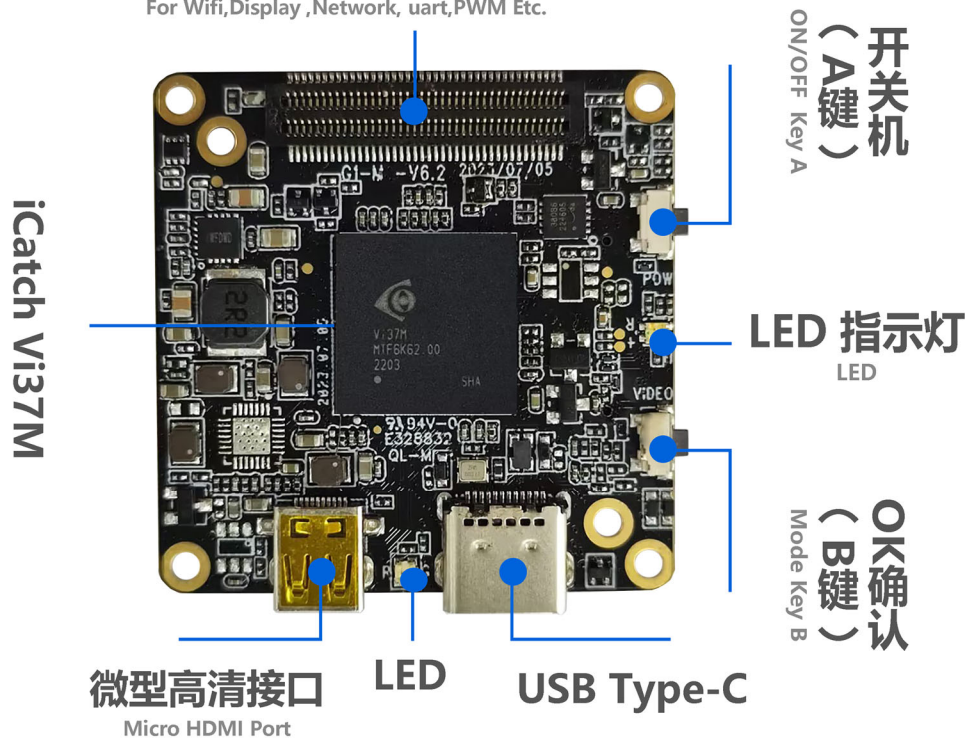



## YDS-G1M9 V6.2

### iCatch V39 Ai-Powered Image Processing SoC Master Board

#### Video Settings

<b>Resolution</b>	16:9 (4K, 2.7K, 1080P, 720P) 4:3 (1440P) Currently Only IMX377 Sensor Supports 1440P
<b>Frame Rate</b>	24FPS, 25FPS, 30FPS, 48FPS, 50FPS, 60FPS, 120FPS, 240FPS
<b>Slow Motion Recording</b>	OFF, 4K2X, 1080P4X, 720P8X
<b>Fast Motion Recording</b>	OFF, 2X, 5X, 10X, 15X, 30X
<b>Automatic Recording</b>	OFF, ON
<b>Time Lapse Video Mode</b>	OFF, 1S, 2S, 3S, 4S, 5S, 6S, 7S, 8S, 10S, 13S, 15S, 20S, 25S, 30S, 40S, 60S
<b>Time Lapse Duration</b>	No Limit, 1min, 3min, 5min, 10min, 20min, 30min, 1hr, 2hr, 3hr, 5hr
<b>Pre-recording</b>	OFF, ON (for Option ON, 5 Seconds of Video is Pre-recorded)
<b>EIS Anti-Shake</b>	OFF, ON
<b>Image Quality Enhancement</b>	Super Good, Very Good, Normal (Referral to Actual Video Effect Quality, Not for Preview)
<b>Image Rotation</b>	Normal, Vertical, Horizontal (for Recorded Video)
<b>Recording Time</b>	No Limit, 1min, 5min
<b>Automatic Screen Off</b>	OFF, 60S, 180S, 300S
<b>Light Metering Mode</b>	Center, Multi-point, Single Point
<b>Video Recording File Time</b>	No Limit, 1min, 5min
<b>Loop Recording</b>	OFF, ON
<b>Recording Volume</b>	0, 1, 2, 3
<b>Video Time Watermark</b>	OFF, Date, Date and Time



## YDS-G1M9 V6.2

### iCatch V39 Ai-Powered Image Processing SoC Master Board

#### System Settings

<b>Automatic Shut Down</b>	OFF, 1min, 3min, 5min, 10min, 15min
<b>USB Auto Power On</b>	Turn ON, Turn OFF
<b>Languages</b>	English, Simplified Chinese, Traditional Chinese (Select Language Through Configuration File in the Card)
<b>Button Touch Tone</b>	Turn ON, Turn OFF
<b>Automatically Turn On WiFi</b>	Turn ON, Turn OFF
<b>WiFi Frequency Bands</b>	2.4GHz or 5GHz (Dual Band Single Channel)
<b>Display Brightness</b>	Low, Medium, High Brightness (for Touch Screen)
<b>Display Setting</b>	Conventional Display, Full Screen Display (for Touch Screen)
<b>Fill Light A (White Light)</b>	Auto, OFF, ON (for Use with Fill Light Board)
<b>Fill Light B (Infrared Light)</b>	Auto, OFF, ON (for Use with Fill Light Board)
<b>IR Cut Settings</b>	Auto, OFF, ON (for Use with IR Cut Function Modules)
<b>Special Effects</b>	Original Image, Black and White, Natural, Negative, Warm Tones, Contrast (for Touch Screen)
<b>White Balance</b>	Auto, Sunny, Cloudy, Fluorescent, Incandescent
<b>Date and Time</b>	Year, Month, Day, Hour, Minute
<b>Format</b>	No, Yes
<b>Reset</b>	No, Yes
<b>Card Information</b>	Displays Video Card Capacity and Free Space
<b>Device Information</b>	Displays Firmware Version

#### Gimbal Functions and Settings

<b>Gimbal Functions</b>	Centering, Calibration
<b>Sensitivity</b>	Follow Softly, Follow Sensitively
<b>Follow Mode</b>	Full Follow, Heading Follow, Heading and Pitch Follow
<b>Pitch Axis Control</b>	Turn ON, Turn OFF





## YDS-G1M9 V6.2

### iCatch V39 Ai-Powered Image Processing SoC Master Board

#### Camera Features

<b>Continuous Shooting</b>	Long Press the OK Button (B) to Shoot Continuously, Release Button to Stop Shooting Continuously
<b>Snapshot</b>	During Recording, Long Press the OK Button (B) to Capture the Video. Release Button to Stop Snapshot
<b>HDMI Output Resolution</b>	4K@30FPS 1080P@60FPS/30FPS 720P@60FPS
<b>Video Start and Stop Function</b>	Short Press the Power Button (A) to Pause or Continue Video Recording
<b>USB Camera Resolution</b>	H.264: 4K@30FPS, 1080P@120FPS, 720P@60FPS (Dependency on Sensor Type and UVC Protocol)  MJPG: 5760x3240@10FPS, 4000x3000@10FPS 4K@30FPS, 1080P@30FPS, 720P@30FPS YUY2: 480P@30FPS (Supports Modification of UVC Output on Configurations)
<b>USB Flash Drive</b>	USB Mode when Connected to Computer
<b>Inverted Mode</b>	By Placing a Configuration File in the Card, You Can Modify the Displayed or Captured file and Flip it 180 degrees
<b>WiFi Mode</b>	AP Mode, STA Mode Set WiFi Mode by Putting Configuration Files in the Card or Enter the Menu to Set This Item Through the Touch Screen
<b>Configuration IP Address</b>	By Placing a Configuration File in the Card, You Can Modify the IP and Gateway Address of the Camera. Default is Static IP. Optional on Dynamic IP.
<b>RTSP Video Stream Address</b>	By Placing a Configuration File in the Card, You Can Modify the RTSP video stream address. If There is No Configuration File in the Card, the Default Port is 554.

## YDS-G1M9 V6.2

### iCatch V39 Ai-Powered Image Processing SoC Master Board

#### USB Type-C Interface:

This interface supports USB standard 5V power input, which can power the master board and charge the battery (recommended 7.4V-7.7V battery). Connecting to a computer can directly read files in the TF card and use it as a USB flash drive. It can also be used as a PCCAM USB camera.

The USB interface retains one camera control serial port UART3 and one camera debugging serial port UART1 (the serial port function can be used with the G1-USB serial port debugging board).

#### Connecting to the Computer USB Flash Drive Mode:

Insert the TF card, connect the other end of the USB to the computer, and automatically enter the USB flash drive mode after booting by default.

#### Connecting to the Computer PCCAM Mode:

Insert the TF card, connect the other end of the USB to the computer, and automatically enter the USB flash drive mode after booting. Short press the OK button (A) to switch to PCCAM camera mode. (Right-click the computer "Computer", click the left button in the pop-up prompt box to enter "Management", "Device Manager", and you can see the name of the camera identified in "Image Device" camera. Open the camera tool "amcap.exe" to see the current device preview screen).

#### Battery Power Supply:

6.6V (low power shutdown) to 8.8V, 7.4-7.7V high-voltage and high-density batteries are recommended  
Special note: the battery power supply can support up to 12V; but this does not include the gimbal version, the stable power supply voltage of the gimbal version is 8V.

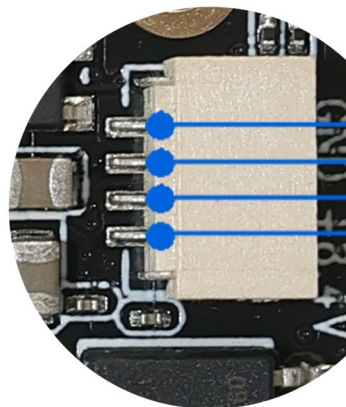
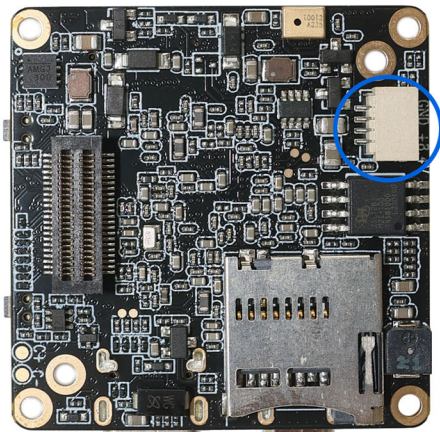

BAT -  
BAT +

Battery 7.7V-8.8V  
电池供电

## YDS-G1M9 V6.2

## iCatch V39 Ai-Powered Image Processing SoC Master Board

**Charge the Battery:**

Use a power adapter (5V2A recommended) to charge the battery of the machine. The red light will be on during charging and the green light will be on when fully charged.

**Camera Module:**

This interface can be used to expand multiple MIPI sensors, IR-CUT function, LED fill light, serial port UART2, battery power output, micro three-axis gimbal and other functions.

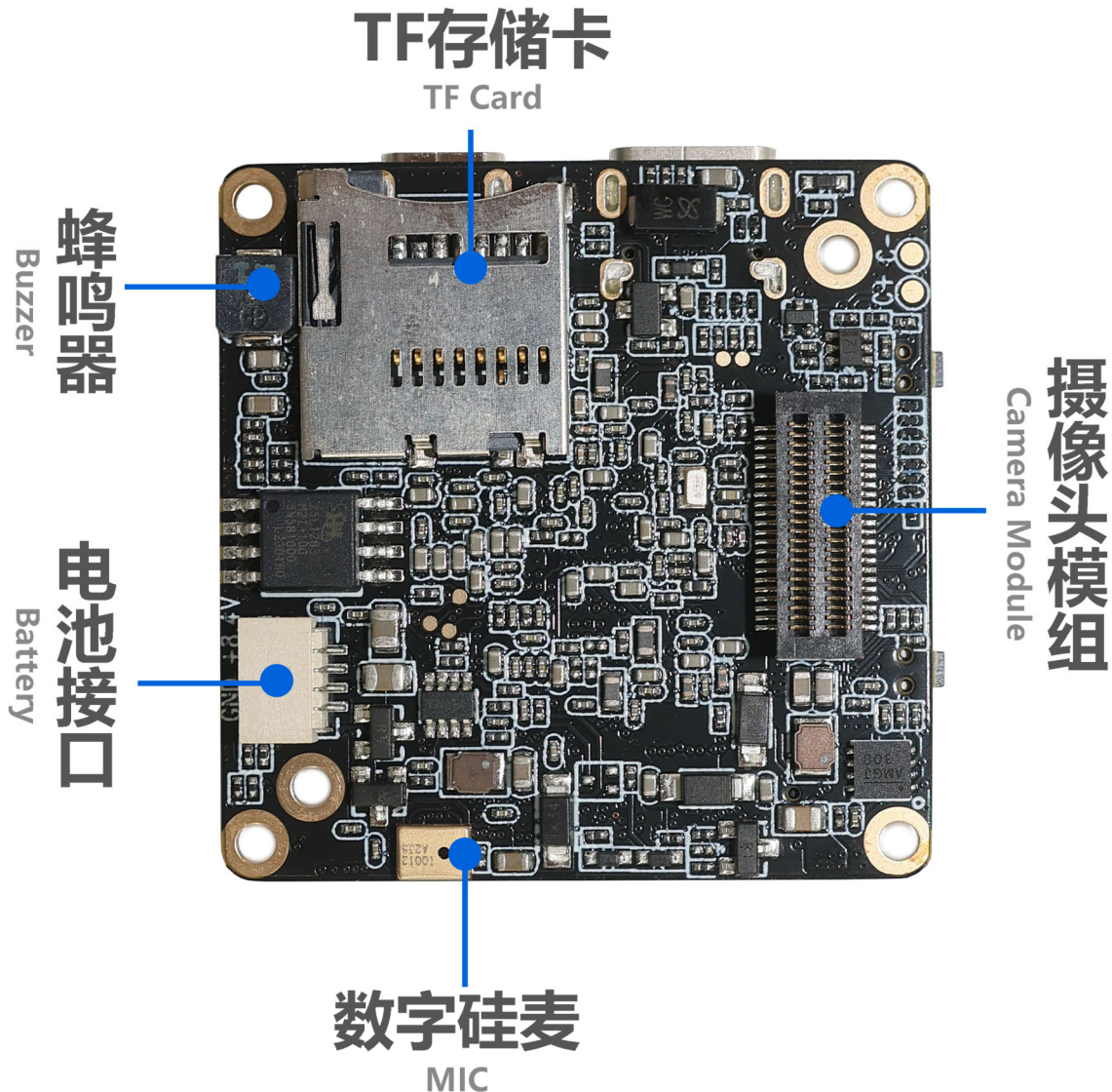



## YDS-G1M9 V6.2

### iCatch V39 Ai-Powered Image Processing SoC Master Board

#### Button Instructions:

Button	Mode or Status	Functional Operation
<b>Button A</b> Power Mode	Power ON / OFF	Long Press 1 Second Power ON / OFF
	Standby	Short Press on Switch Mode Video Recording, Snapshot, Playback, Settings
	Setting Mode (with Touch Screen)	Short Press to Scroll Down Menu (After Pressing Button B to Enter Setting)
	Video Recording	Short Press to Pause or Continue Recording
<b>Button B</b> Confirmation OK Video Recording	Standby	In Video Standby Mode, Long Press 3 Seconds to Turn ON / OFF WiFi Mode. Default WiFi is OFF. In Video Recording Mode, Short Press to Start Recording In Snapshot Mode, Short Press to Start Taking Photo Long Press to Start Continue Shooting Release to Stop Continue Shooting
	Video Recording	Short Press to Stop Recording and Save the File Long Press 2 Seconds (Less than 4 Seconds) to Take a Single Frame Shot, Release to Stop Taking Frame Shots Long Press 5 Seconds to Take Continues Frame Shots, Release to Stop Taking Frame Shots
	Setting Mode (with Touch Screen)	Short Press to Confirm and Enter Setting Mode Long Press 2 Seconds to Return Double-Click to Switch Between Settings: Photo / Video / System / 3-Axis Gimbal
	Playback Mode (with Touch Screen)	Short Press to Scroll Up Menu Double-Click to Play / Pause Video or Audio Files Click 3 Times to Mark or Unmark Files. If File is Marked, then the File is Locked and Not Erasable Long Press to Prompt Option to Delete Current File (Long Press to Delete, Short Press to Return) After Entering, Long Press Again to Delete
	Shutdown	Press and Hold to Enter the USB Burning Mode
<b>Reset Function</b>	Standby or Working	Press Button A and B at the Same Time to Shutdown



## YDS-G1M9 V6.2

### iCatch V39 Ai-Powered Image Processing SoC Master Board

#### LED Indicator Description:

Functions	Color	Power On	Video Mode	Video Recording	Photo Mode	Photo Snapshot	Playback Mode	Setting Mode
LED Indicator	Red	Always On	Always On	Flashing			Always On	
	Green				Always On	Flash Once	Always On	
	Blue						Always On	Always On

Note: When the device is powered without a TF card inserted, the function indicator light flashes yellow.

#### Buzzer Sound Description:

Operation Mode	Power On	Power Off	Switching Mode	Start Video Recording	Start Stop Recording	Photo Snapshot	Menu Setting	Menu Scroll Down	Exit Menu Setting
Buzzer Sound	3 Beeps	5 Beeps	1 Beep	1 Beep	2 Beeps	1 Beep	1 Beep	1 Beep	1 Beep

Special Note: When the touch screen is not in use, you can modify the setting parameters through the configuration file. Put the configuration file, such as "CameraConfig\_G1A.ini" (the specific configuration file name will vary depending on the lens module) in the root directory of the TF card, and you can modify the corresponding function options in the configuration file. After saving the changes, shut down the machine and restart it to take effect.

## YDS-G1WF V6.3 WiFi Expansion Board

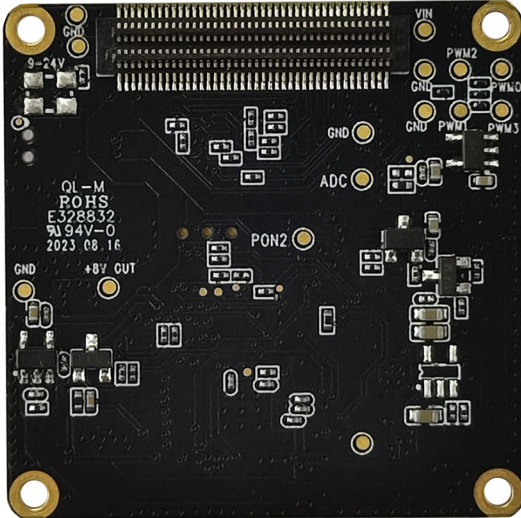

Front View

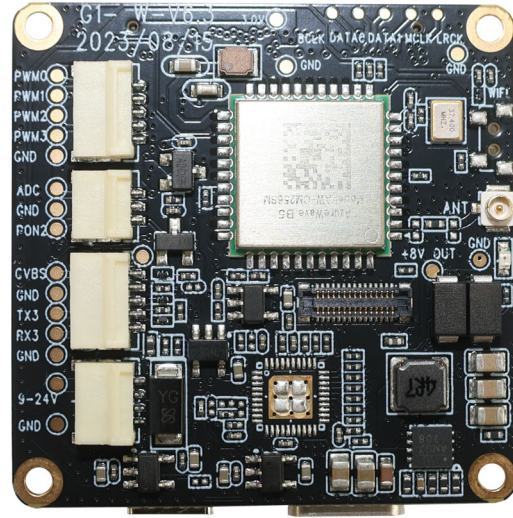

Back View

### Overview

WiFi expansion board is equipped with the AW CM256SM single-pass dual-band WiFi module, which supports the use of single-band 2.4GHz or 5GHz wireless WiFi functions. The board supports WiFi antenna, reserved WiFi button (Button C), serial port (UART3), etc.

PWM, ADC button, touch screen and other expansion interfaces included. The board PCB size is 38x38mm, and it must be used with our company's designated master board. This WiFi board can not work independently.



## YDS-G1WF V6.3 WiFi Expansion Board

### Specifications

<b>Model No.</b>	<b>YDS-G1WF V6.3</b>
<b>WiFi Module</b>	AW CM256SM
<b>Power Supply</b>	Supports 3 Power Supply Methods At The Same Time (1) 5V USB to Type-C Port Power Supply (2) 9V-24V WiFi Board Power Supply (3) 6.8V-8.4V Battery Power Supply (The 3-Axis Gimbal Version Does Not Support 5V USB)
<b>WiFi Frequency Bands</b>	2.4GHz or 5GHz (Dual Band Single Channel)
<b>Wireless Network Standards</b>	IEEE 802.11B/G/N/AC, WiFi Compliant
<b>2.4GHz Frequency Range</b>	2.400GHz - 2.472GHz (2.4GHz ISM Band)
<b>2.4GHz Channels</b>	2.4GHz: Channel 1 - Channel 13
<b>2.4GHz Transmission Rate</b>	2 - 3 Megabytes
<b>2.4GHz Transmission Distance</b>	50 Meters (No Disruption)
<b>5GHz Frequency Range</b>	5.150GHz - 5.825GHz (5GHz ISM Band)
<b>5GHz Channels</b>	5GHz: Channel 1 - Channel 13
<b>5GHz Transmission Rate</b>	6 - 8 Megabytes
<b>5GHz Transmission Distance</b>	30 Meters (No Disruption)
<b>CVBS (TV-Out)</b>	720 x 576
<b>CVBS Standards</b>	NTSC / PAL (TV-Out)
<b>Serial Port / UART</b>	RX3, TX3, GND
<b>ADC Button</b>	Up, Down, Left, Right, OK 5-Way ADC Buttons Power Button
<b>Operating Temperature</b>	-10°C to +60°C Without Housing
<b>Storage Temperature</b>	-20°C to +80°C
<b>Humidity</b>	20% to 80%
<b>PCB Dimensions</b>	38 x 38 mm
<b>PCB Screw Hole Spacing</b>	34 mm
<b>PCB Screw Hole Diameter</b>	2 mm
<b>Extendable Functions</b>	PWM, ADC Buttons, WiFi Board Power Supply UART3 Serial Port, Touch Screen, Other Interfaces

## YDS-G1WF V6.3 WiFi Expansion Board

### Hardware Interface Function Description

AW CM256SM single-pass dual-band WiFi module supports single-band 2.4GHz or 5GHz wireless WiFi function, and adopts the first generation IPEX universal copper standard antenna.

In the video mode standby state, long press the master board Button B, that is, long press the motherboard shooting button for 3S to turn on WiFi. The red light flashes when WiFi is turned on, and the red light is always on after the connection is successful.

**PWM接口**  
PWM port

**无线WiFi模组**  
WiFi Module

**ADC  
5向按键**  
ADC Five Keys

**控制串口**  
Control  
(uart) port

**WiFi天线**  
WiFi Antenna

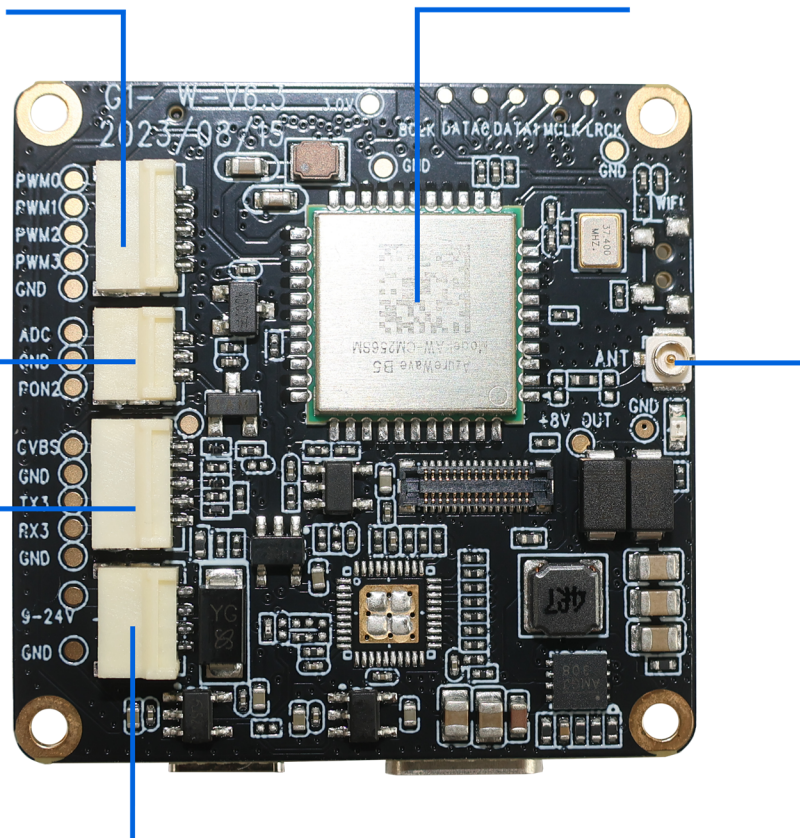

### 9~24Vwifi板上电控制相机开机

The wifi board power supply control camera is turned on



## YDS-G1WF V6.3 WiFi Expansion Board

The PWM function interface, which can be used to control camera mode switching, photo taking, video recording and other functions.

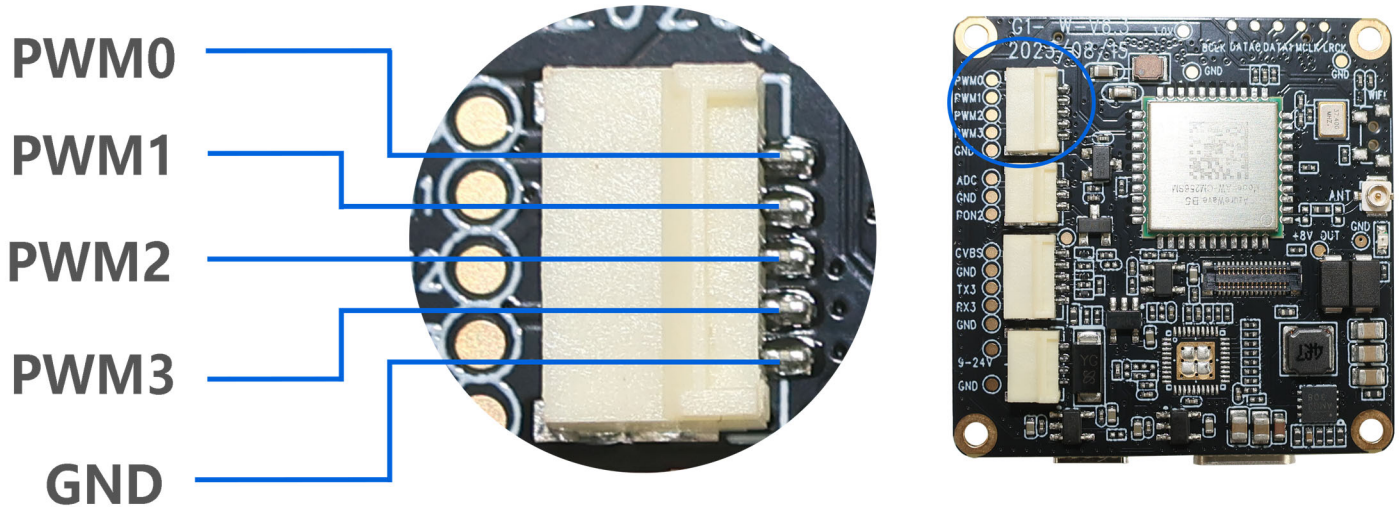

Supports one ADC button interface, which can be connected to five buttons: up, down, left, right, and OK, to control the camera's recording, taking pictures, turning on WiFi, etc. Supports external buttons to control the camera's power on and off.

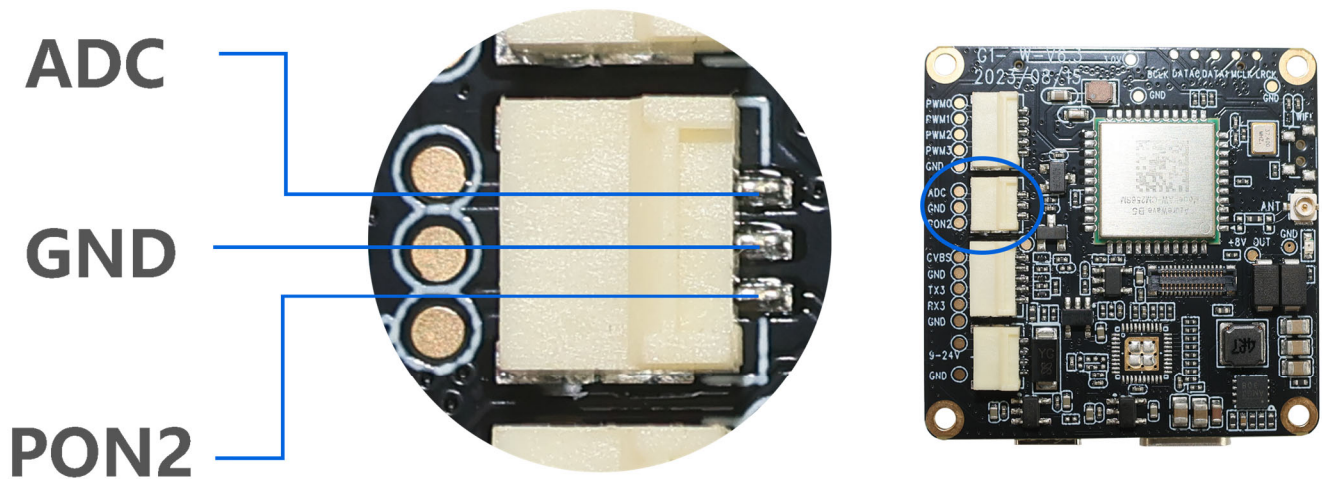

## YDS-G1WF V6.3 WiFi Expansion Board

Supports one analog video CVBS (TV-OUT) signal output, with RX3 and TX3 reserved ports, and the camera can be set and controlled through this serial port.

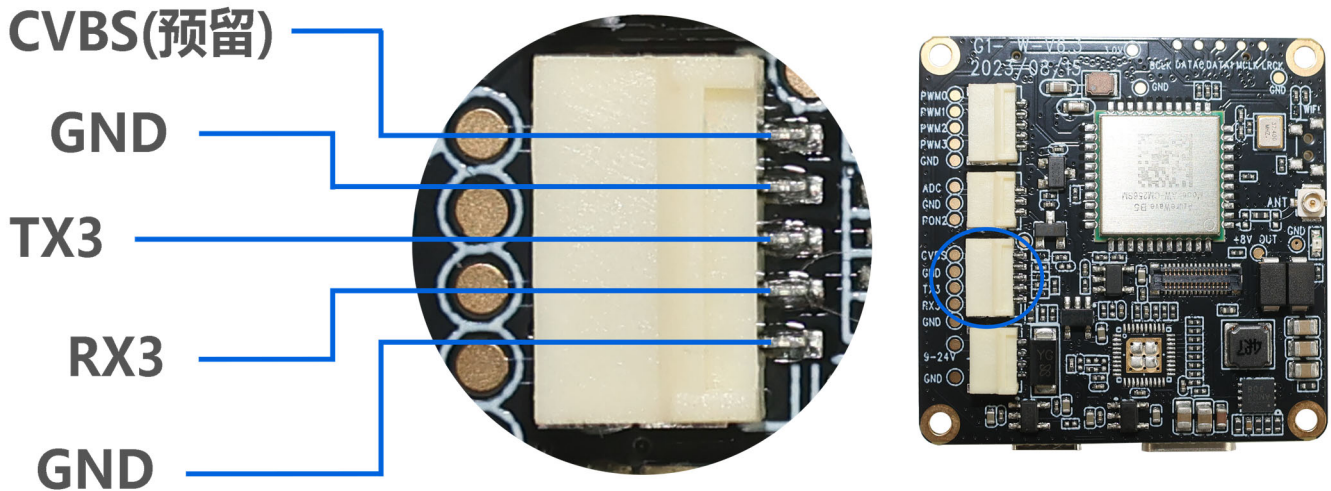

The camera can be powered on automatically using 9V-24V power supply; the master board supports three-way simultaneous use, namely WiFi board power supply, motherboard battery power supply, and Type-C USB power supply. It can also be used with a single power supply.

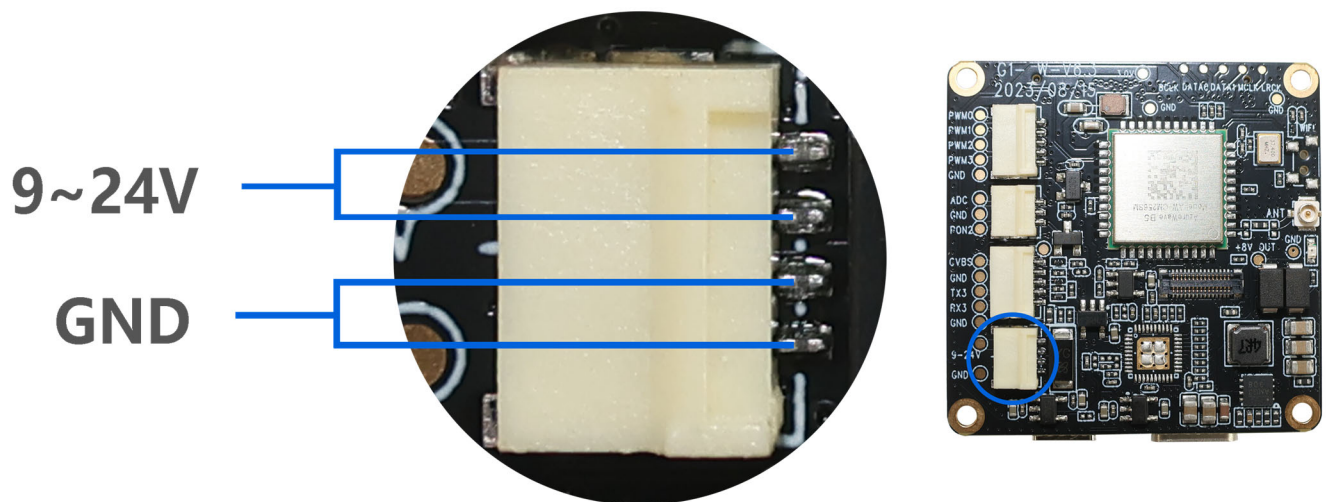

## YDS-G1WF V6.3 WiFi Expansion Board

Special note:

The three-axis gimbal does not support 5V USB power supply alone. The battery power supply can support up to 12V; but this does not include the gimbal version, the stable power supply voltage of the battery for gimbal version is 8V.

## wifi板连接主板扩展板接口

wifi board connect to main board

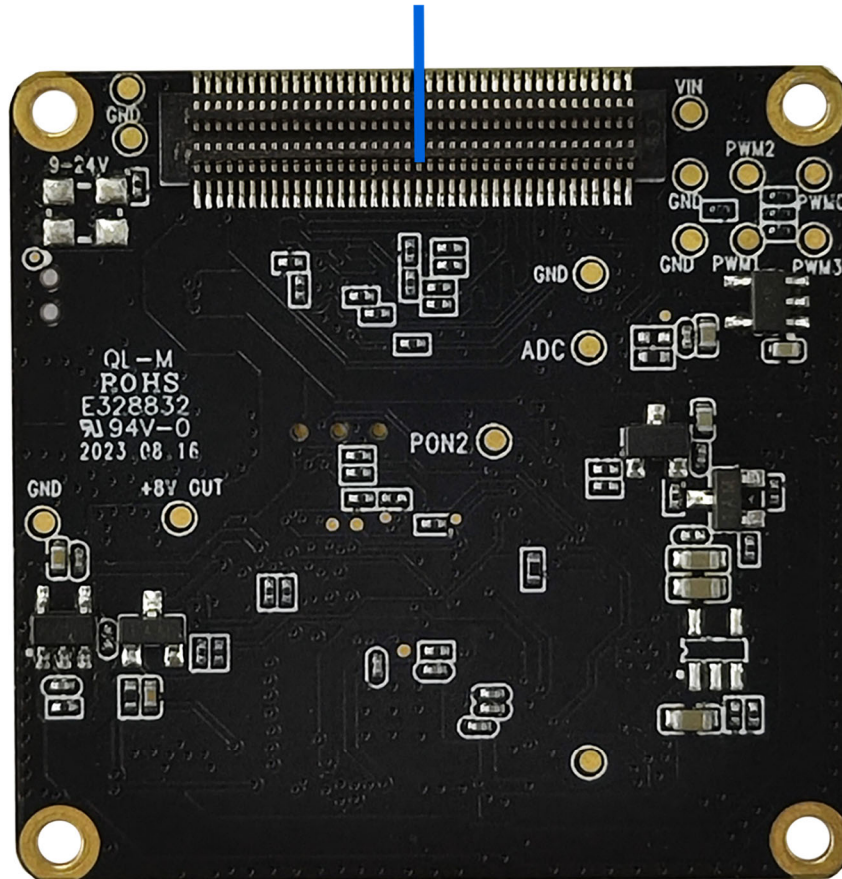

## YDS-CMFL1117C-IMX283 V1.0 20.3MP Sony IMX283 Fixed Focus Camera Module

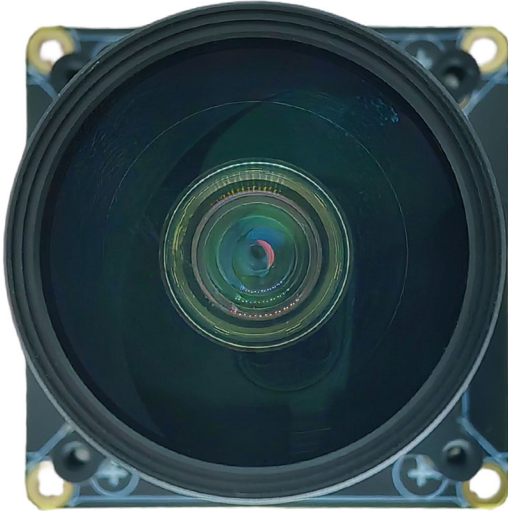

Front View

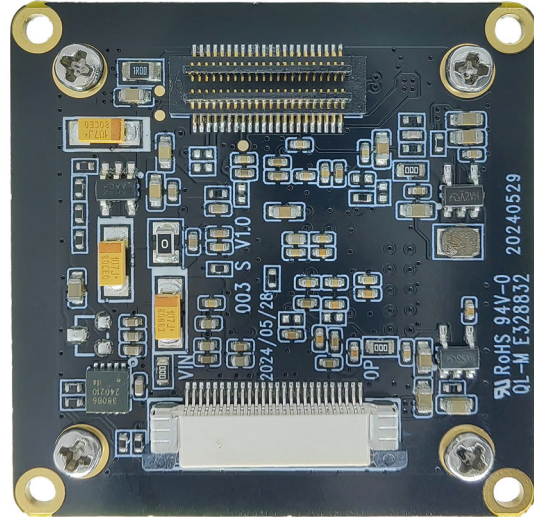

Back View

### Overview

The YDS-CMFL1117C-IMX283 V1.0 camera module uses the Sony IMX283 high-quality image sensor, which has a diagonal of 15.86mm (1 inch) CMOS image sensor, a pixel of 2.4 $\mu$ m, a color square pixel display, an effective pixel of 20.30 megapixels, and a high-definition image.

When used with the master board, it can support 20MP pixel high-definition photography, up to 4K@60FPS (differential), 4K@30FPS video shooting, with the characteristics of true color restoration and excellent image quality. It is connected by a board-to-board socket. The board PCB frame size is 38x38mm.



## YDS-CMFL1117C-IMX283 V1.0 20.3MP Sony IMX283 Fixed Focus Camera Module



Top View



Side View



Bottom View

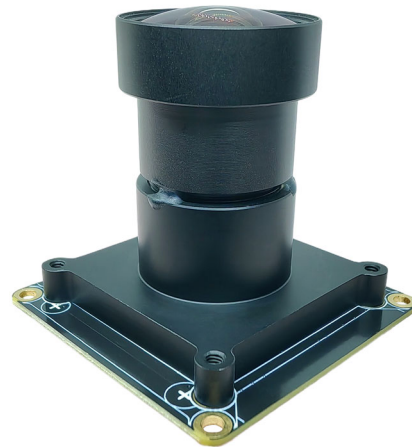

Isometric View



## YDS-CMFL1117C-IMX283 V1.0 20.3MP Sony IMX283 Fixed Focus Camera Module

### Specifications

<b>Model No.</b>	<b>YDS-CMFL1117C-IMX283 V1.0</b>
<b>Image Sensor</b>	IMX283
<b>Image Sensor Type</b>	CMOS
<b>Effective Pixels</b>	20.30 Megapixels
<b>Sensor Size</b>	1"
<b>Pixel Size</b>	2.40 um x 2.40 um
<b>Video Frame Rate</b>	4K@24/25/30/FPS, 4K@48/50/60FPS (Differential) 2.7K@24/25/30/48/50/60FPS 1440@24/25/30/48/50/60FPS 1080P@24/25/30/48/50/60/120FPS 720P@24/25/30/48/50/60/120/240FPS
<b>Video Slow Motion</b>	OFF, 4K2X, 1080P4X, 720P8X
<b>Photo Format</b>	JPG
<b>Photo Resolution (with Master Board)</b>	20MP (5200x3900) 13MP (4160x3120) 12MP (4000x3000) 10MP (3648x2736) 8MP (3264x2448) 5MP (2592x1944) 3MP (2048x1536) 2MP (1920x1080)
<b>Operating Temperature</b>	-10°C to +60°C
<b>Storage Temperature</b>	-20°C to +80°C
<b>Humidity</b>	20% to 80%
<b>PCB Dimensions</b>	38 x 38 mm
<b>Module Size</b>	38 x 38 x 38 mm
<b>PCB Screw Hole Spacing</b>	Spacing 34 x 34 mm (External) 28 x 28 mm (Internal)
<b>PCB Screw Hole Diameter</b>	2 mm
<b>Lens Mount Screw Diameter</b>	2.1 mm

## YDS-CMFL1117C-IMX283 V1.0 20.3MP Sony IMX283 Fixed Focus Camera Module

### Lens Specifications

Lens Model No.	L1117C
TTL (Total Length)	30.22 mm
EFL	6.60 mm
F. No.	2.8
Diagonal View Angle (DFOV)	102° (DFOV)
Horizontal View Angle (HFOV)	91.8° (HFOV)
Vertical View Angle (VFOV)	68° (VFOV)
Distortion	<0.3%
Relative Illumination	>32.8%
Lens Operating Temperature	-30°C to +75°C
Lens Storage Temperature	-40°C to +85°C

### Lens Drawing

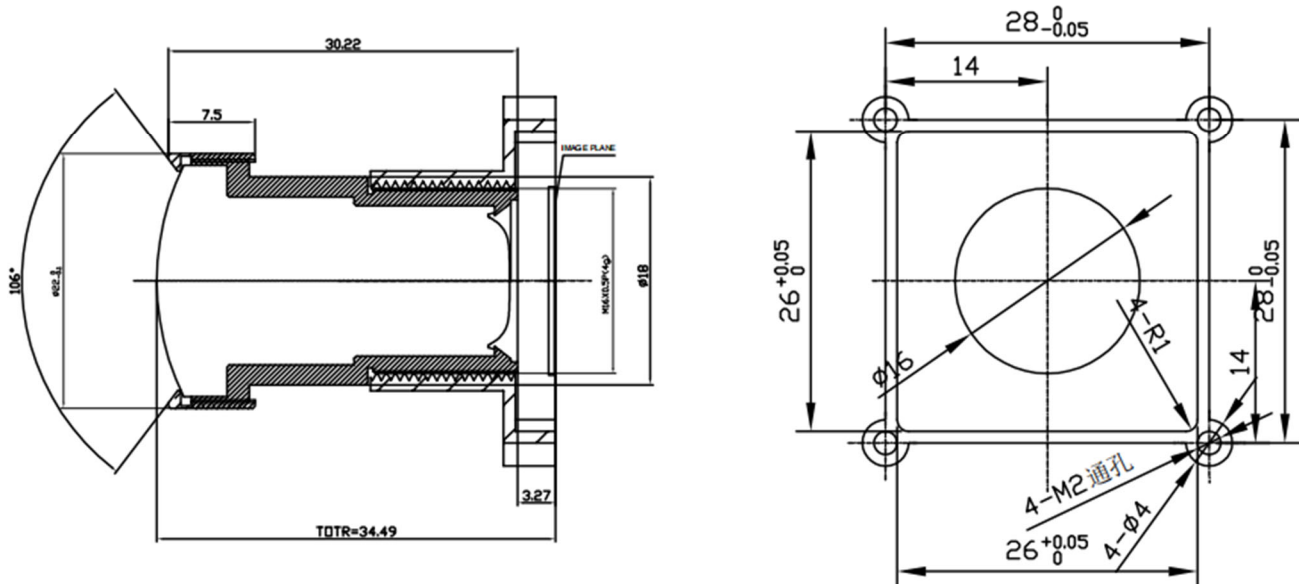

## YDS-CMFL1117C-IMX283 V1.0 20.3MP Sony IMX283 Fixed Focus Camera Module

G1 IMX283 L1117C 镜头模组

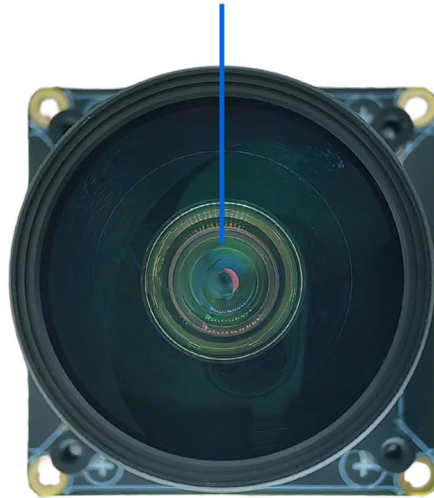

通过板对板连接器连接G1主板  
Connect Sensor

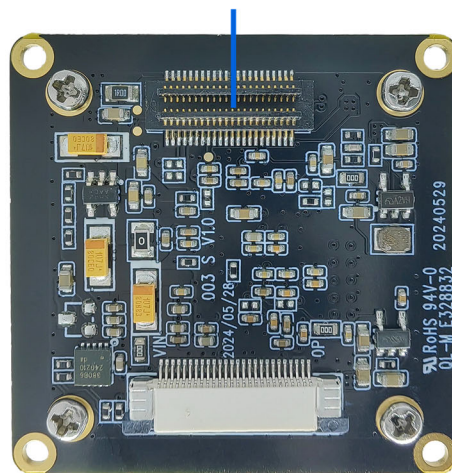



## [Product Information]

Ver.1.0

# IMX283CQJ

Diagonal 15.86 mm (Type 1) CMOS Image Sensor with Square Pixel for Color Cameras

---

### Description

The IMX283CQJ is a diagonal 15.86 mm (Type 1) CMOS image sensor with a color square pixel array and approximately 20.30 M effective pixels. 12-bit digital output makes it possible to output the signals of approximately 20.30 M effective pixels with high definition for shooting still pictures. It also operates with three power supply voltages: analog 2.9 V, digital 1.2 V and 1.8 V, and achieves low power consumption. Furthermore, it realizes 12-bit digital output for shooting high-speed and high-definition moving pictures by horizontal and vertical addition and subsampling. Realizing high-sensitivity, low dark current, this sensor also has an electronic shutter function with variable storage time.

In addition, this product is designed for use in consumer use digital still camera and consumer use camcorder. When using this for another application, Sony Semiconductor Solutions Corporation does not guarantee the quality and reliability of the product. Therefore, don't use this for applications other than consumer use digital still camera and consumer use camcorder.

In addition, individual specification change cannot be supported because this is a standard product.

Consult your Sony Semiconductor Solutions Corporation sales representative if you have any questions.

---

### Features

- ◆ CMOS active pixel type pixels
- ◆ Input clock frequency 6 to 27 MHz
- ◆ MIPI Specifications (CSI-2 high-speed serial interface)
- ◆ All-pixel scan mode
  - Various readout modes (\*)
- ◆ High-sensitivity, low dark current, no smear, excellent anti-blooming characteristics
- ◆ Vertical and horizontal arbitrary cropping function
- ◆ Variable-speed shutter function (minimum unit: 1 horizontal period)
- ◆ Low power consumption
- ◆ H driver, V driver and I<sup>2</sup>C communication circuit on chip
- ◆ CDS/PGA on chip: Gain +27 dB (step pitch 0.1 dB)
- ◆ 9-bit/10-bit/12-bit A/D conversion on chip
- ◆ R, G, B primary color mosaic filters on chip
- ◆ 118-pin high-precision ceramic package

\* Please refer to the datasheet for binning/subsampling details of readout modes.

Sony reserves the right to change products and specifications without prior notice.  
Sony logo is a registered trademark of Sony Corporation.

## Device Structure

◆ CMOS image sensor	
◆ Image size	Diagonal 15.86 mm (Type 1)
◆ Total number of pixels	5592 (H) × 3710 (V) approx. 20.75 M pixels
◆ Number of effective pixels	
- Type 1 approx. 20.30 M pixels use	5496 (H) × 3694 (V) approx. 20.30 M pixels
- Type 1/1.4 approx. 8.42 M pixels use	3872 (H) × 2174 (V) approx. 8.42 M pixels
◆ Number of active pixels	
- Type 1 approx. 20.30 M pixels use	5496 (H) × 3672 (V) approx. 20.18 M pixels diagonal 15.86 mm
- Type 1/1.4 approx. 8.42 M pixels use	3872 (H) × 2168 (V) approx. 8.39 M pixels diagonal 10.65 mm
◆ Number of recommended recording pixels	
- Type 1 approx. 20.30 M pixels use	5472 (H) × 3648 (V) approx. 19.96 M pixels aspect ratio 3:2
- Type 1/1.4 approx. 8.42 M pixels use	3840 (H) × 2160 (V) approx. 8.29 M pixels aspect ratio 16:9
◆ Chip size	16.226 mm (H) × 12.654 mm (V) (include scribe area)
◆ Unit cell size	2.40 μm (H) × 2.40 μm (V)
◆ Optical black	Horizontal (H) direction : Front 48 pixels, rear 0 pixel Vertical (V) direction : Front 16 pixels, rear 0 pixel
◆ Package	118 pin LGA

## Image Sensor Characteristics

(T<sub>j</sub> = 60 °C)

Item	Value	Remarks
Sensitivity (F5.6)	Typ. 1874 digit	1/30 s integration
Saturation signal	Min. 3824 digit	

## Basic Drive Mode

### Type 1 Approx. 20.30 M Pixels (3:2)

Drive mode	Number of recording pixels	Max frame rate [frame/s]	Output data bit length [bit]
Readout mode 0	5472 (H) × 3648 (V) approx. 19.96 M pixels	21.40	12
Readout mode 1	5472 (H) × 3648 (V) approx. 19.96 M pixels	25.48	10
Readout mode 1A	5472 (H) × 3078 (V) approx. 16.84 M pixels	30.17	10
Readout mode 1S	3000 (H) × 3000 (V) approx. 9.00 M pixels	42.96	10
Readout mode 2	2736 (H) × 1824 (V) approx. 4.99 M pixels	51.80	12
Readout mode 2A	2736 (H) × 1538 (V) approx. 4.21 M pixels	60.27	12
Readout mode 3	1824 (H) × 1216 (V) approx. 2.22 M pixels	60.36	12
Readout mode 4	1824 (H) × 370 (V) approx. 0.67 M pixels	240.21	12
Readout mode 5	1824 (H) × 190 (V) approx. 0.35 M pixels	452.03	12
Readout mode 6	2736 (H) × 1538 (V) approx. 4.21 M pixels	60.01	10

### Type 1/1.4 Approx. 8.42 M Pixels (16:9)

Drive mode	Number of recording pixels	Max frame rate [frame/s]	Output data bit length [bit]
Readout mode 1	3840 (H) × 2160 (V) approx. 8.29 M pixels	60.16	10

## Cameras Applications



Automotive Driver Pilot



Live Streaming



Video Conference



Eye Tracker Biometric Detection

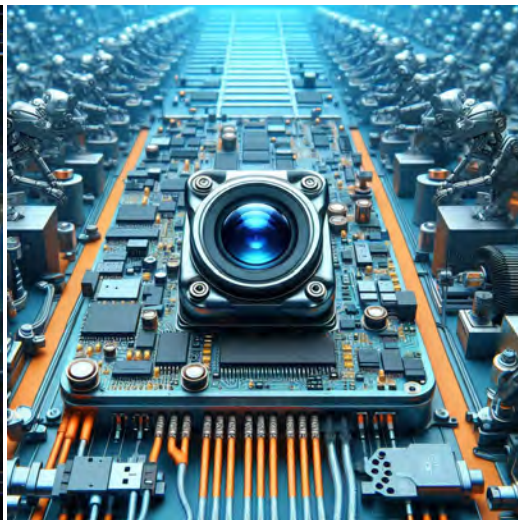

Machine Vision



Agricultural Monitor



Night Vision Security



Drone and Sports Eagle Eyes



Interactive Pet Camera



# YDS CAMERA MODULE

*your best camera partner*

## Camera Module Pinout Definition Reference Chart

OmniVision	Sony	Samsung	On-Semi	Aptina	Himax	GalaxyCore	PixArt	SmartSens	Sensors
Pin Signal		Description							
DGND GND		ground for digital circuit							
AGND		ground for analog circuit							
PCLK DCK		DVP PCLK output							
XCLR PWDN XSHUTDOWN STANDBY		power down active high with internal pull-down resistor							
MCLK XVCLK XCLK INCK		system input clock							
RESET RST		reset active low with internal pull-up resistor							
NC NULL		no connect							
SDA SIO_D SIOD		SCCB data							
SCL SIO_C SIOC		SCCB input clock							
VSYNC XVS FSYNC		DVP VSYNC output							
HREF XHS		DVP HREF output							
DOVDD		power for I/O circuit							
AFVDD		power for VCM circuit							
AVDD		power for analog circuit							
DVDD		power for digital circuit							
STROBE FSTROBE		strobe output							
FSIN		synchronize the VSYNC signal from the other sensor							
SID		SCCB last bit ID input							
ILPWM		mechanical shutter output indicator							
FREQ		frame exposure / mechanical shutter							
GPIO		general purpose inputs							
SLASEL		I2C slave address select							
AFEN		CEN chip enable active high on VCM driver IC							
<b>MIPI Interface</b>									
MDN0 DN0 MD0N DATA_N DMO1N		MIPI 1st data lane negative output							
MDP0 DP0 MD0P DATA_P DMO1P		MIPI 1st data lane positive output							
MDN1 DN1 MD1N DATA2_N DMO2N		MIPI 2nd data lane negative output							
MDP1 DP1 MD1P DATA2_P DMO2P		MIPI 2nd data lane positive output							
MDN2 DN2 MD2N DATA3_N DMO3N		MIPI 3rd data lane negative output							
MDP2 DP2 MD2P DATA3_P DMO3P		MIPI 3rd data lane positive output							
MDN3 DN3 MD3N DATA4_N DMO4N		MIPI 4th data lane negative output							
MDP3 DP3 MD3P DATA4_P DMO4P		MIPI 4th data lane positive output							
MCN CLKN CLK_N DCKN		MIPI clock negative output							
MCP CLKP MCP CLK_P DCKN		MIPI clock positive output							
<b>DVP Parallel Interface</b>									
D0 DO0 Y0		DVP data output port 0							
D1 DO1 Y1		DVP data output port 1							
D2 DO2 Y2		DVP data output port 2							
D3 DO3 Y3		DVP data output port 3							
D4 DO4 Y4		DVP data output port 4							
D5 DO5 Y5		DVP data output port 5							
D6 DO6 Y6		DVP data output port 6							
D7 DO7 Y7		DVP data output port 7							
D8 DO8 Y8		DVP data output port 8							
D9 DO9 Y9		DVP data output port 9							
D10 DO10 Y10		DVP data output port 10							
D11 DO11 Y11		DVP data output port 11							

[www.YDSCAM.com](http://www.YDSCAM.com) [sales@ydscam.com](mailto:sales@ydscam.com) Phone (WeChat, QQ): (+86) 177 2732 6718

All rights reserved @ YingDeShun Co. Ltd. Specifications subject to change without notice.

## Camera Reliability Test

Reliability Inspection Item		Testing Method	Acceptance Criteria	
Category	Item			
Environmental	Storage Temperature	High 60°C 96 Hours	Temperature Chamber	No Abnormal Situation
		Low -20°C 96 Hours	Temperature Chamber	No Abnormal Situation
	Operation Temperature	High 60°C 24 Hours	Temperature Chamber	No Abnormal Situation
		Low -20°C 24 Hours	Temperature Chamber	No Abnormal Situation
	Humidity	60°C 80% 24 Hours	Temperature Chamber	No Abnormal Situation
	Thermal Shock	High 60°C 0.5 Hours Low -20°C 0.5 Hours Cycling in 24 Hours	Temperature Chamber	No Abnormal Situation
Physical	Drop Test (Free Falling)	Without Package 60cm	10 Times on Wood Floor	Electrically Functional
		With Package 60cm	10 Times on Wood Floor	Electrically Functional
	Vibration Test	50Hz X-Axis 2mm 30min	Vibration Table	Electrically Functional
		50Hz Y-Axis 2mm 30min	Vibration Table	Electrically Functional
		50Hz Z-Axis 2mm 30min	Vibration Table	Electrically Functional
	Cable Tensile Strength Test	Loading Weight 4 kg 60 Seconds Cycling in 24 Hours	Tensile Testing Machine	Electrically Functional
Electrical	ESD Test	Contact Discharge 2 KV	ESD Testing Machine	Electrically Functional
		Air Discharge 4 KV	ESD Testing Machine	Electrically Functional
	Aging Test	On/Off 30 Seconds Cycling in 24 Hours	Power Switch	Electrically Functional
	USB Connector	On/Off 250 Times	Plug and Unplug	Electrically Functional



## Camera Inspection Standard

Inspection Item		Inspection Method	Standard of Inspection		
Category	Item				
Appearance	FPC/ PCB	Color	The Naked Eye	Major Difference is Not Allowed.	
		Be Torn/Chopped	The Naked Eye	Copper Crack Exposure is Not Allowed.	
		Marking	The Naked Eye	Clear, Recognizable (Within 30cm Distance)	
	Holder	Scratches	The Naked Eye	The Inside Crack Exposure is Not Allowed	
		Gap	The Naked Eye	Meet the Height Standard	
		Screw	The Naked Eye	Make Sure Screws Are Presented (If Any)	
		Damage	The Naked Eye	The Inside Crack Exposure is Not Allowed	
	Lens	Scratch	The Naked Eye	No Effect On Resolution Standard	
		Contamination	The Naked Eye	No Effect On Resolution Standard	
		Oil Film	The Naked Eye	No Effect On Resolution Standard	
		Cover Tape	The Naked Eye	No Issue On Appearance.	
	Function	Image	No Communication	Test Board	Not Allowed
			Bright Pixel	Black Board	Not Allowed In the Image Center
Dark Pixel			White board	Not Allowed In the Image Center	
Blurry			The Naked Eye	Not Allowed	
No Image			The Naked Eye	Not Allowed	
Vertical Line			The Naked Eye	Not Allowed	
Horizontal Line			The Naked Eye	Not Allowed	
Light Leakage			The Naked Eye	Not Allowed	
Blinking Image			The Naked Eye	Not Allowed	
Bruise			Inspection Jig	Not Allowed	
Resolution			Chart	Follows Outgoing Inspection Chart Standard	
Color			The Naked Eye	No Issue	
Noise			The Naked Eye	Not Allowed	
Corner Dark			The Naked Eye	Less Than 100px By 100px	
Color Resolution			The Naked Eye	No Issue	
Dimension	Height	The Naked Eye	Follows Approval Data Sheet		
	Width	The Naked Eye	Follows Approval Data Sheet		
	Length	The Naked Eye	Follows Approval Data Sheet		
	Overall	The Naked Eye	Follows Approval Data Sheet		

## YDSCAM Package Solutions

YDS Camera Module



Complete with Lens Protection Film

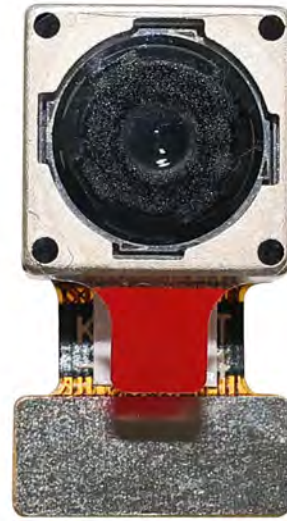

Tray with Grid and Space



Place Cameras on the Tray

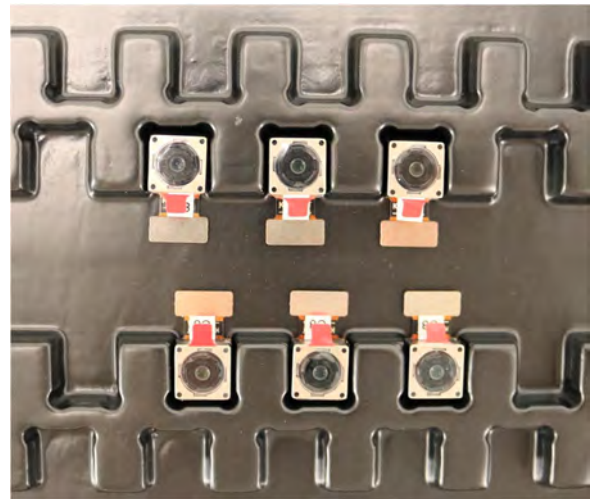

## YDSCAM Package Solutions

Full Tray of Cameras

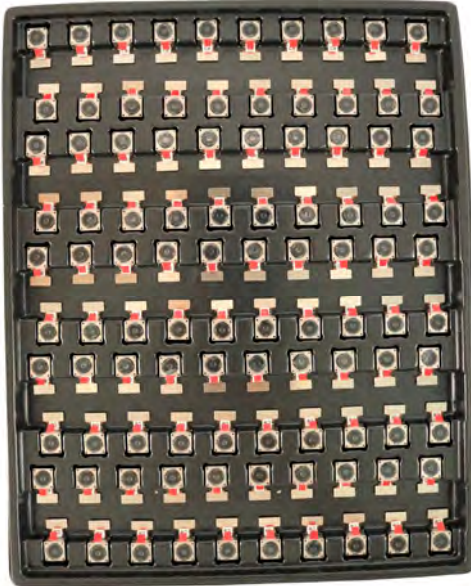

Cover Tray with Lid

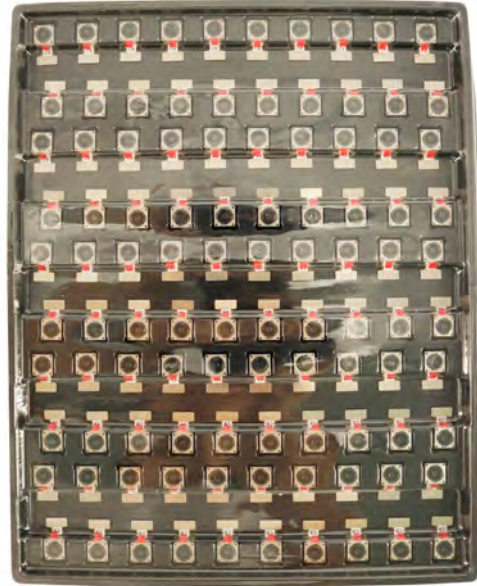

Place Tray into Anti-Static Bag



Vacuum the Anti-Static Bag





## YDSCAM Package Solutions

### Sealed Vacuum Anti-Static Bag with Labels

1. Model and Description 2. Quantity 3. Manufacturing Date Code 4. Caution



## YDSCAM Package Solutions

Place Foam Sheets Between Tray Bags



Foam Sheets are Larger Than Trays



Place Foam Sheets and Trays into Box



Foam Sheets are Tightly Fitting in Box



Seal the Carbon Box



Label the Carbon Shipping Box





## YDSCAM Package Solutions

USB Camera Module

Complete with Lens Protection Film



Place Camera Sample into Anti-Static Bag

Place USB Cameras into Tray



Seal the Tray with Anti-Static Bag

Label the Carbon Shipping Box



## YDSCAM Package Solutions

Place Camera Sample into Anti-Static Bag



Place Connectors into Anti-Static Bag



Label the Sample Bags



Place Connectors into Reel



Place Samples into the Carbon Box



Place Connectors into the Carbon Box





# YDS CAMERA MODULE

*your best camera partner*

## Company YDSCAM

YingDeShun Co. Ltd. (YDS) was established in 2017, a next-generation technology driven manufacturer specialized in research, design, and produce of audio and video products. YDS is occupying 20,000 square feet automated plants with 100 employees of annual throughput 30,000,000 units cameras.

YDS provides OEM, ODM design, contract manufacturing, and builds the camera products. You may provide the requirements to us, even with a hand draft, our sales and engineering work together to meet your needs. We consider ourselves your last-term partner in developing practical and innovative solutions.

Our team covers everything from initial concept development to mass produced product. YDS specializes in customized camera design, raw material, electronic engineering, firmware/software development, product testing, and packing design. Our experienced strategic supply systems offer a robust and dependable manufacturing capacity for orders of various sizes.

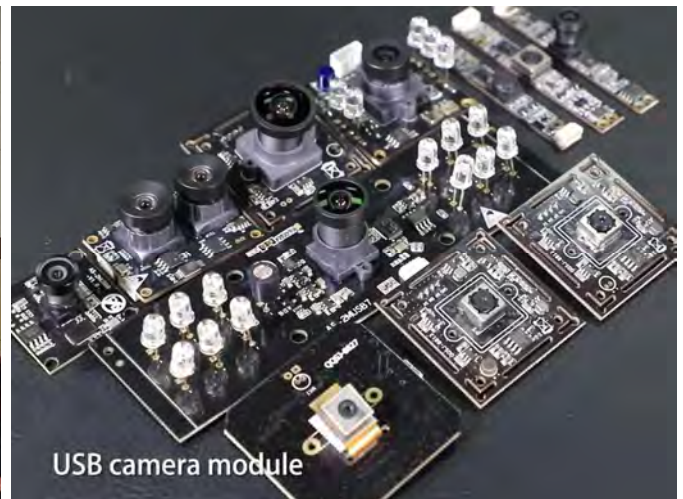

## Limited Warranty

YDS provides the following limited warranty if you purchased the Product(s) directly from YDS company or from YDS's website [www.YDSCAM.com](http://www.YDSCAM.com). Product(s) purchased from other sellers or sources are not covered by this Limited Warranty. YDS guarantees that the Product(s) will be free from defects in materials and workmanship under normal use for a period of one (1) year from the date you receive the product ("Warranty Period").

For all Product(s) that contain or develop material defects in materials or workmanship during the Warranty Period, YDS will, at its sole option, either: (i) repair the Product(s); (ii) replace the Product(s) with a new or refurbished Product(s) (replacement Product(s) being of identical model or functional equivalent); or (iii) provide you a refund of the price you paid for the Product(s).

This Limited Warranty of YDS is solely limited to repair and/or replacement on the terms set forth above. YDS is not reliable or responsible for any subsequent events.



[www.YDSCAM.com](http://www.YDSCAM.com) [sales@ydscom.com](mailto:sales@ydscom.com) Phone (WeChat, QQ): (+86) 177 2732 6718

All rights reserved @ YingDeShun Co. Ltd. Specifications subject to change without notice.



# YDS CAMERA MODULE

*your best camera partner*

## YDS Strength

### Powerful Factory



### Professional Service



### Promised Delivery



[www.YDSCAM.com](http://www.YDSCAM.com) [sales@ydscam.com](mailto:sales@ydscam.com) Phone (WeChat, QQ): (+86) 177 2732 6718

All rights reserved @ YingDeShun Co. Ltd. Specifications subject to change without notice.